





ULTRA LOW FREEZER

U85 / C85 / PH85 / PV85 SERIES

INSTRUCTIONS

USER MANUAL

WARNING: READ BEFORE CONTINUING	
To reduce the risk of fire, electric shock or injury to persons using this freezer, read all instructions and follow basic safety precautions before using the unit, including the following:	
	Do not modify the plug provided with the freezer. If it will not fit the outlet, have a proper outlet installed by a qualified electrician.
	Do not position equipment so it is difficult to disconnect from the power supply. freezer must be at least 6" away from any wall or object on any side.
	While under warranty, do not attempt to repair or replace any part of the freezer for servicing without first contacting the So-Low Service Department.
SAVE THESE INSTRUCTIONS	

So-Low Environmental Equipment Company
10310 Spartan Drive
Cincinnati, OH 45215-1221
Tel: 513-772-9410
<http://www.so-low.com>

For customer service:
Email: sales@so-low.com

For parts replacement:
Email: parts@so-low.com

For technical support:
Email: service@so-low.com

CONTENTS

◆ SYMBOLS AND STARTING INSTRUCTIONS.....	1
• MEANING OF ILLUSTRATED SYMBOLS.....	1
• STARTING INSTRUCTIONS.....	1
◆ UNIT REQUIREMENTS.....	2
• PRE-INSTALLATION INFORMATION.....	2
◆ PREVENTATIVE MAINTENANCE.....	3
• FREEZER STORAGE PROCEDURE.....	3
• ALARM BATTERY REPLACEMENT.....	4
• CLEANING PROCEDURE.....	5
• DEFROSTING PROCEDURE.....	5
• CLEANING AIR CONDENSER.....	6
◆ UNIT OPERATION.....	7
• CHANGING SETPOINT / OPERATION TEMPERATURE.....	7
◆ ALARM OPERATION.....	8
• ALARM SYSTEM.....	8
• DRY CONTACT RELAY.....	8
◆ CONTROL PROGRAMMING.....	9
• CONTROL KEYS & DISPLAYS.....	9
• CONTROL DISPLAY VALUES.....	10
• USER PARAMETER MODE.....	10
• PROGRAM PARAMETER MODE.....	11
• CALIBRATION PROCEDURE.....	12
◆ FREQUENTLY ASKED QUESTIONS.....	13
◆ REPLACEMENT PARTS LIST.....	14
◆ TECHNICAL SUPPORT.....	15
◆ MAINTENANCE CHECKLIST.....	16
◆ DIAGRAMS.....	17

SYMBOLS AND STARTING INSTRUCTIONS

Explanation

MEANING OF ILLUSTRATED SYMBOLS

ILLUSTRATED SYMBOLS

Various symbols are used in this safety manual in order to use the unit without danger of injury and damage of the unit. Be sure that you understand the warnings and cautions in this manual before operating the unit.



CAUTION

BLACK WITH YELLOW BACKGROUND
LIGHTNING BOLT
CAUTION, RISK OF ELECTRICAL SHOCK



WARNING

BLACK WITH YELLOW BACKGROUND
EXCLAMATION POINT
CAUTION, REFER TO ACCOMPANYING DOCUMENTS

STARTING INSTRUCTIONS

1. Move the freezer to an indoor location, and plug the freezer into an appropriate outlet with an adequate power supply. Consult your maintenance department for additional information on the proper electrical configuration for this unit.
2. Once plugged in, the compressor(s) will start to operate and pull down to the setpoint on the temperature control. The freezers default setpoint is **-85°C** for cascade units, and **-40°C** for single stage units.
3. Allow the freezer to reach the setpoint temperature. Depending on the size of the unit, this may take up to 12 hours.
4. Product can now be loaded into the freezer for storage.



To prevent overloading the cooling system, product should be loaded gradually, in batches. Allow the temperature to recover to setpoint before the next batch of product is loaded into the unit.

Unit Information

PRE-INSTALLATION INFORMATION

RANGE OF ENVIRONMENTAL CONDITIONS FOR WHICH THIS EQUIPMENT IS DESIGNED

1. Indoor use.
2. Altitude up to 2000m.
3. Ambient temperatures 15°C to 30°C (60°F TO 85°F)
4. Recommended humidity range of 30% to 90%.
5. Mains supply fluctuations up to -5% to +10% of the nominal voltage.
6. Transient over-voltages typically present on the mains supply (overvoltage category II). Pollution degree 1.



WARNING

DURING OPERATION THIS UNIT MUST REMAIN IN UPRIGHT POSITION. DURING TRANSPORTATION UNIT MUST NOT BE TIPPED MORE THAN 45° FROM UPRIGHT POSITION.



CAUTION

UNPLUG UNIT AND SWITCH OFF ELECTRICAL BREAKER BEFORE ANY TECHNICAL SERVICE IS PERFORMED.



CAUTION

COVERS ON BACK / SIDE OF FREEZER MAY ONLY BE REMOVED BY AUTHORIZED PERSONNEL. FAILURE TO RE-INSTALL COVER COULD RESULT IN HAZARD.



CAUTION

UNIT MUST BE OPERATED ON A DEDICATED ELECTRICAL LINE. USING A NON-DEDICATED LINE MAY RESULT IN UNIT STARTUP FAILURE.



CAUTION

ONLY PLUG THIS UNIT INTO THE PROPER OUTLET. DO NOT ATTEMPT TO MODIFY PLUG IN ANY WAY. IMPROPER USE OF THE ELECTRICAL PLUG WILL VOID WARRANTY.



WARNING

DO NOT POSITION EQUIPMENT SO IT IS DIFFICULT TO DISCONNECT FROM THE POWER SUPPLY.

FREEZER STORAGE PROCEDURE

The unit can be turned off for storage by unplugging the unit from the wall outlet and/or switching off the electrical breaker in the electrical box.



ATTENTION

RISK OF ELECTRICAL SHOCK
USE CAUTION NEAR ELECTRICAL CONNECTIONS

Once the unit is unplugged, the freezer will go into “Power Failure” alarm. To disable the Power Failure alarm;

1. Locate the electrical panel on the side of the freezer.
2. Remove the screws with a Phillips screwdriver, and remove the panel.
3. Locate the battery (which is clearly marked) in the lower right hand corner.
4. Disconnect one lead from the battery by removing the connector on the battery.

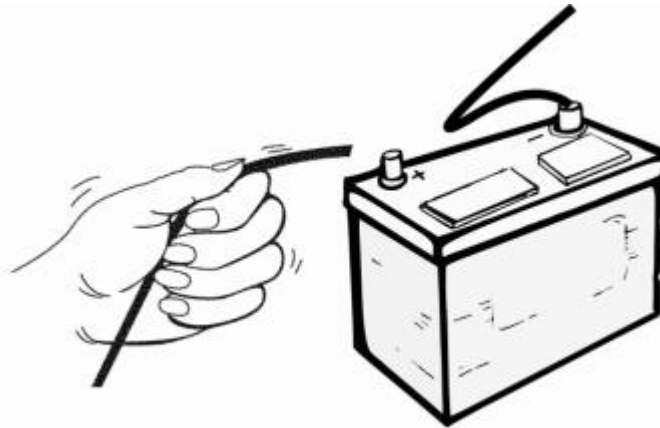

5. When returning the unit to service, complete steps 1-4, but reconnect the unplugged battery in step 4. Then plug the unit into the outlet to restore power.



NOTICE

SEE STARTING INSTRUCTIONS ON PAGE 1 WHEN
PUTTING UNIT BACK INTO SERVICE.

ALARM BATTERY REPLACEMENT



NOTICE

THE LO-BAT (LOW BATTERY ALARM) IS NOT ABLE TO BE SILENCED OR DISABLED.

TO REDUCE THE VOLUME OF THE ALARM UNTIL A REPLACEMENT CAN BE INSTALLED, A PIECE OF TAPE CAN BE PLACED OVER THE BUZZER HOLE ON THE CONTROL

To reduce the risk of fire, electric shock or injury to persons using this freezer, read all instructions and follow basic safety precautions.



CAUTION

DISCONNECT THIS UNIT FROM THE POWER SUPPLY BEFORE PERFORMING MAINTENANCE ON THE UNIT.

1. Unplug freezer from power supply.
2. Remove cover marked electrical panel located on side of cabinet.
3. Disconnect wires from battery terminals – Note which color wires were connected to positive/negative. Colors vary depending on when unit was made. Older models used black wire as positive and white as negative. Newer models use red wire as positive and black as negative. See picture for battery location.
4. Remove strap holding battery in place.
5. Replace battery and reconnect wires (see #3)
6. Test alarm.
7. Reinstall battery strap and electrical box cover.
8. Plug freezer back into power supply, and allow up to 24 hours for the new battery to fully charge.



CLEANING PROCEDURE

Wipe down the exterior of the freezer with a soft cloth and/or general spray type polish. Do not use corrosive cleaners/chemicals on the exterior.

If frost builds up in the chamber, a bucket and ice-scraper can be used to remove ice. If excessive ice builds up, the unit can be defrosted (see below).

DEFROST PROCEDURE

1. Remove any product in the freezer, and temporarily store it in a back-up freezer or elsewhere.
2. Unplug the freezer, and fully open the freezer front door / lid.



ATTENTION

FOR UPRIGHT UNITS, IT IS IMPORTANT TO PROTECT THE CONTROL FROM DRIPPING WATER. PLACE A CLOTH OR TOWEL ON THE LEADING EDGE OF THE COOLING CHAMBER ABOVE THE CONTROL TO DEFLECT / ABSORB WATER THAT COULD DRAIN ONTO THE CONTROL.

3. Air out the freezer, allowing the unit to reach room temperature for at least 12 hours. Using fans to blow air into the unit is recommended.
4. Take a rag and wipe up all the excess water in the unit (melted frost).
5. Close the unit, and plug the unit in to activate the start-up process.

PLEASE CONSULT THE START-UP INSTRUCTIONS ON PAGE 1 FOR UNIT STARTUP

6. Once the desired temperature is reached, you may slowly begin to add your product back into the unit.
-
-



ATTENTION

IT IS RECOMMENDED TO SLOWLY RE-ADD YOUR PRODUCT INTO THE FREEZER TO PREVENT AN EXTREME LOAD ON THE COMPRESSORS, WHICH COULD SHORTEN FREEZER LIFE EXPECTANCY.

CLEANING AIR CONDENSER

Large amounts of dust build-up on the air-cooled condenser can cause excess stress for the refrigeration system. This excess stress may increase the chance of a refrigeration issue and reduce the life expectancy of the refrigeration system.



ATTENTION

IT IS RECOMMENDED TO CLEAN THE CONDENSER AT LEAST ONCE EVERY 90 DAYS TO PREVENT DUST BUILDUP.

1. Using a Philips Head screwdriver, remove the screws for grill located on front of unit. Once the screws are removed, the front grill can be removed allowing easy access to the air cooled condenser.

Note: It is recommended to keep the screws in a safe location, so they can be used to re-attach the grill once cleaning is completed.

2. Use a vacuum cleaner to pull up any dust built up on the condenser fins. The most efficient method of doing this is using a furniture cleaning attachment (if available).

Note: Cans of compressed air can also be used to blow away dust, however this is not the most recommended way to clean the condenser; as the dust may float through the air and eventually return to clog the condenser.

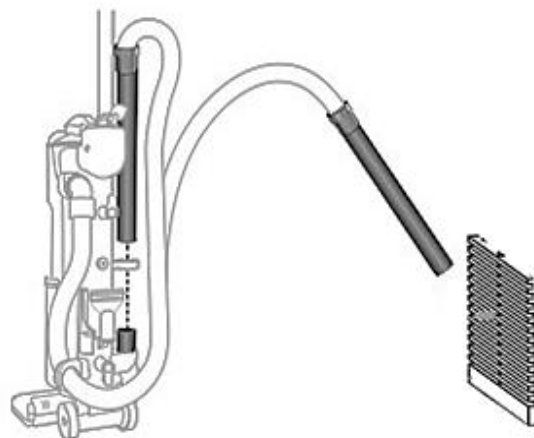

3. Once clean, re-align the front grill and attach it using a screwdriver.

CHANGING SETPOINT TEMPERATURE

The temperature control is manually adjustable to the desired temperature in 1° C increments within the limits of the control range.

TEMPERATURE SET POINT

The control has two displays;

- 1) The upper display (**TEMP**) is the current actual unit temperature.
- 2) The lower display (**SET**) is the temperature set point.

The temperature set point has been pre-set at the factory. See page 1 for additional information on factory default setpoint.

CHANGING TEMPERATURE SETPOINT

The temperature set point can be changed by simply pressing the “up” arrow to raise or the “down” arrow to lower the temperature set point.

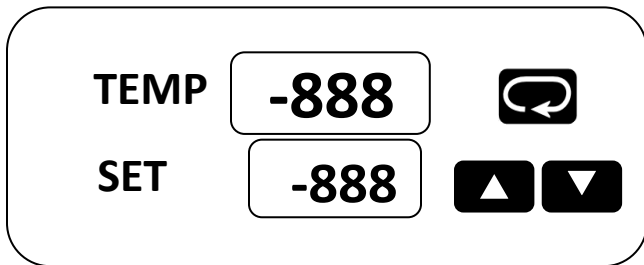

WARNING



CHANGING THE CONTROL PARAMETERS OUTSIDE OF THE MANUFACTURE RECOMMENDED RANGE, COULD SHORTEN THE LIFE-SPAN OF YOUR EQUIPMENT; OR CAUSE ISSUES RESULTING IN MECHANICAL FAILURE.

WARNING



USE ONLY THE “UP” AND “DOWN” KEYS WHEN MAKING CHANGES ON THIS CONTROL. WARRANTY WILL BE VOID IF USED IN ANY OTHER WAY.

CONTACT FACTORY FOR ALL OTHER ADJUSTMENTS IN SETTINGS.

ALARM / RELAY OPERATION

ALARM SYSTEM

When operating the unit for the first time, the alarm will be disabled until the unit reaches set point, or 8 hours after the unit has been first plugged in. The alarm will not sound again until the unit goes out of temperature range.

THE FACTORY DEFAULT ALARM RANGE IS $\pm 12^{\circ}\text{C}$ (20°F) FROM SETPOINT.

Note: The freezer contains a back-up battery, which will power the alarm system for approximately 48 hours during a power outage.

ALARM SYSTEM BATTERY REPLACEMENT

- Rechargeable batteries should be changed approximately every three years with lead acid rechargeable 1.2 Ah min, model PS-640F1 or equivalent.



ATTENTION

THE BATTERY DOES NOT POWER THE COOLING SYSTEM.

DRY CONTACT RELAY

The dry contact relay is a terminal strip located on the back of the freezer.

RATING OF THIS CONNECTION:

2A 125 VAC

2A 30 VDC

RED – NORMALLY CLOSED
WHITE – COMMON
BLUE – NORMALLY OPEN







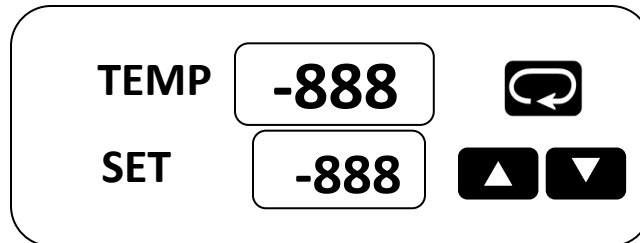

WARNING

IF IT IS NECESSARY TO REMOVE METAL COVER SCREEN ON BACK OF FREEZER TO MAKE CONNECTIONS TO ALARM RELAY, COVER MUST BE REPLACED BEFORE FREEZER IS PUT INTO OPERATION

CONTROL KEYS & DISPLAYS

The FDC-4000 controller is programmed by using three keys on the front panel. The available key functions are listed in following table. Note: Only use the tip of your finger to depress the keys. Using a rigid object such as a pen, screwdriver or even your finger-nail may permanently damage the keypad.



TOUCH KEYS	FUNCTION	DESCRIPTION
	Up Key	Press and release to increase the control set-point (while in normal control mode) or to change lower display program parameter (while in User Menu or Factory Mode). Press and hold to accelerate increment speed.
	Down Key	Press and release to decrease the control set-point (while in normal control mode) or to change lower display program parameter (while in User Menu or Factory Mode). Press and hold to accelerate decrement speed.
 Pressing key while in normal control mode	Scroll Key	Press and hold for at least 2 seconds and release (while in normal control mode) to access operator level parameters. Press and release to cycle through all user parameters. Press and hold for 2 seconds and release to silence audible alarm under normal power or on battery power. While unit is in an alarm condition, the external alarm relay contacts will remain energized until the alarm condition no longer exists. Press and hold to display chamber temperature while the controller is on battery power. Chamber temperature will be displayed until key is released. Alarm contact will remain energized while operating on battery power.
Press both keys  simultaneously	Current Power Reading	Displays current AC power (i.e. 110VAC) as long as keys are pressed. If power is 110VAC or 220VAC, unit will display 110. Mode is only active during normal control mode (when top display = PV, Lower display = SP). N/A on battery power.
Press both keys  simultaneously	Alarm Test	Energize audible alarm and alarm relay output as long as keys are pressed. Mode is only active during normal control mode (when top display = PV, Lower display = SP). N/A on battery power.

Note: When the controller is displaying temperature in normal control mode, press/release or press/hold the up/down keys to change the set-point value. This set-point mode does not apply to power off modes.

CONTROL DISPLAY VALUES

A	A	E	E	I	I	N	n	S	S	X	
B	b	F	F	J	J	O	o	T	t	Y	y
C	C	G	G	K	Y	P	P	U	u	Z	
C	c	H	H	L	L	Q		V	<u>u</u>	?	?
D	d	h	h	M	N	R	r	W		=	=
 : Confused Character											

The upper display is used to show the process value or menu prompt. The lower display is used to show the set-point value or menu value. Both displays are blank while on battery power unless the  button is pressed to display the process value. Note: When operating on battery power, the battery status LED (labeled “BAT” on the front panel) will be lit.

USER PARAMETER MODE

To enter the USER parameter mode, hold the scroll key for 2 seconds and release.



To enter the user parameter mode, hold the Scroll Button for 2 seconds and release.



To make changes in the user parameter mode, press the up or down arrows.



To exit the user parameter mode, press and release the Scroll Button.

PROGRAM PARAMETER MODE

To enter the PROGRAM parameter mode, hold the scroll key until the screen changes to 'SPL', then release. This will take approximately 15 seconds.



To page through Parameters; Press and Release the scroll key



Please read the superscript instructions (bottom of page) for each Parameter value.

THE FOLLOWING VALUES WERE SET WHEN THIS UNIT WAS SHIPPED

PARAMETERS	DESCRIPTION	°F	°C	ON	OFF
SPL ³	Lower Setpoint	-148	-100		X
SPH ³	Upper Setpoint	-40	-40		X
AI ²	Alarm			X	
INV ¹	Temperature Scale	°F	°C		X
SHF ¹	Calibration				X
ASP ¹	Alarm Differential	22	12		X
AHY ^{3,1}	Alarm Hysteresis	1.8	1.0		X
OHY ^{3,1}	Output Hysteresis	3.6	2.0		X
RB ¹	Alarm Delay in Minutes		30		X
DoR ⁴	Door Alarm				X
SP ²	Setpoint			X	
IN2 ⁴	N / A	N / A			

TO EXIT TAP SCROLL KEY REPEATEDLY UNTIL TEMPERATURE/SETPOINT SCREEN APPEARS

1) This parameter has been turned "on" by pressing either arrow key and then make your changes in "user" mode.

THE VALUES TO BE CHANGED ARE DISPLAYED IN USER MODE ONLY, except SPL and SPH.

2) No values to change, either enable or disable by pressing the ▲ or ▼ arrow buttons.

3) Any changes made here without expressed permission from the manufacturer will VOID the warranty of the unit.

4) The parameter "DoR" and IN2 cannot be utilized at this time.

CALIBRATION PROCEDURE

To calibrate the control, the calibration parameter must be turned on.

To enter the CALIBRATION mode, hold the scroll key until the screen changes to 'SPL', then release. This will take approximately 15 seconds.







Press and Release the scroll key to page through Parameters.



Once value SHF is shown, Use the or arrow keys to change value to ON.

PARAMETERS	DESCRIPTION	°F	°C	ON	OFF
SPL ³	Lower Setpoint				
SPH ³	Upper Setpoint				
AI ²	Alarm				
INV ¹	Temperature Scale				
SHF ¹	Calibration			X	

ONCE THE CALIBRATION PARAMETER HAS BEEN TURNED ON

- Hold SCROLL KEY  for 2 seconds and release. SHF should appear in the top display and the current calibration value should appear in the bottom display.
- The value can now be changed with UP  or DOWN  arrow keys.
- Once finished, press and release the SCROLL KEY  to return to the main screen.

COMMON QUESTIONS

Q: When should I defrost my unit?

A: Units should be defrosted when ice accumulation reaches approximately 1/2 inch thick. Ice acts like an insulator and has to work harder to reach the same temperature.

Q: Is this unit self-defrosting?

A: No, this unit is a manual defrost unit.

Q: Should I leave my freezer operating when I am not using it?

A: This unit is designed to operate continuously. Leaving the refrigeration system in operation, (even if not in use) may extend the life of the freezer, and reduce the chance of refrigeration issues that may occur if the freezer is not in operation for long periods of time.

Q: What ambient conditions is this unit designed for?

A: This unit is designed for:

- Indoor use
- Altitude up to 2000m.
- Temperatures 15°C to 32°C (60°F TO 85°F)
- Recommended humidity range of 30% to 90%.

Q: What electrical conditions is this unit designed for?

A: This unit is designed for:

- Mains supply fluctuations up to -5% to +10% of the nominal voltage. Consult the serial tag for nominal voltage.
- Transient overvoltage typically present on the mains supply (overvoltage category II). Pollution degree 1.

Q: Does my unit require a dedicated electrical line?

A: Yes, this unit requires a dedicated electrical line.

Please consult the labels on your unit for specific electrical requirements.

Q: Will the backup battery keep my unit cool during power failure?

A: NO, the backup battery only powers the alarm during power failure. It will not power the refrigeration system, and will not keep the unit cooling during power outages.

Q: Will the freezer start up after a power outage?

A: Yes, the freezer will automatically re-start when power is restored.

The overall restart process will begin in stages to prevent system overloads; and may take up to minutes after re-start before cooling resumes.

REPLACEMENT PARTS LIST

COMPRESSOR MODEL	HP	VOLTAGE	HERTZ	PHASE	PART #
TECUMSEH AJB2433ZXA	1	115	50/60	1	AJB24-115
TECUMSEH AJB2433ZXD	1	208/220/230	50/60	1	AJB24-208
EMBRACO FFI12HBX	1/3	115	50/60	1	FF12-115
DANFOSS SC15FTX	1/3	115	50/60	1	SC15-115
DANFOSS SC18FTX	1/2	208/220/230	50/60	1	SC15-208

TEMPERATURE CONTROL PARTS	PART #
FDC 4000	4000
FDC nCOMPASS	nCOMPASS

CASCADE ELECTRICAL PARTS	PART #
Heater Harness No. H-200	217-VOLTAGE
Refrigeration Switch No. 2X464	TOGGLE
Condenser Fan Motor No. GE-5411 - 115/60/1	500-115
Condenser Fan Motor No. GE-5421 - 230/50-60/1	500-VOLTAGE
Electrical Cord No. 8-3 (Please Specify Voltage)	PWRCRD-VOLTAGE
Control Board No. CECB2TUV (Please Specify Voltage)	231-VOLTAGE

REFRIGERATION HIGH STAGE PARTS	PART #
Air Cooled Condenser No. 3CZ0602B	254
Drier No. C-053-S	256H
Capillary Tube	HS-17, HS-20
Oil Separator, Temprite Series 900 (If Applicable)	900

REFRIGERATION LOW STAGE PARTS	PART #
Pressure Control No. 20PS01-0039	259
Receiver Condenser	RCN-LS
Drier No. CO-52S-S	256L
Capillary Tube	LS-28, LS-31
Oil Separator, Temprite Series 900 (If Applicable)	900

HARDWARE PARTS	PART #
Latch No. METL-L1-99	REX37L1-3
Chest Hinge	59-928M
Upright Hinge No. Polar 109-LH	59-928U
Cabinet Gasket	NX504B1
Lid or Door Gasket	PSOS
Grill No. 650H	356F, 356S
Sub-Lids (Must have Model Number)	SL-MODEL NUMBER
Inner Door (Must have Model & Serial Number)	357-MODEL NUMBER-SERIAL NUMBER
Clips & Rollers for Inner Doors (Quantity 10 minimum)	405
Shelves for Freezer (Must have Model Number)	4015-MODEL NUMBER

TECHNICAL ASSISTANCE

IN CASE OF REQUEST FOR REPAIR

If failure occurs, stop operation of unit, and turn OFF the breaker power switch located in the electrical panel box, and unplug the power plug.



WARNING

IF FAILURE OCCURS AND UNIT IS STILL UNDER WARRANTY, DO NOT ATTEMPT TO MAKE ANY REPAIR MODIFICATIONS TO THE UNIT BEFORE CONTACTING THE SO-LOW SERVICE DEPARTMENT, AS THIS MAY RESULT IN WARRANTY BEING VOIDED.

< CHECK FOLLOWING ITEMS BEFORE CALLING OR EMAILING >

◆ Model Number of Product

◆ Serial Number of Product

◆ Issue (as detailed as possible)

So-Low Environmental Equipment Company
10310 Spartan Drive
Cincinnati, OH 45215-1221
Tel: 513-772-9410
<http://www.so-low.com>

For customer service:
Email: sales@so-low.com

For parts replacement:
Email: parts@so-low.com

For technical support:
Email: service@so-low.com

MAINTENANCE CHECKLIST

IT IS RECOMMENDED TO COMPLETE CHECKLIST EVERY 30 DAYS

◆ MODEL NUMBER OF PRODUCT

◆ SERIAL NUMBER OF PRODUCT

Checked that freezer is operating at the correct setpoint temperature.

Checked operation of condenser fans, and cleaned air cooled condenser.

Confirmed unit is at least 6 inches away from walls, or obstacles, on all sides to allow for sufficient air flow.

Confirmed ambient room temperature is within range acceptable ranges.
Recommended room temperature range is 15°C to 26°C (60°F TO 80°F)

◆ **AMBIENT ROOM TEMPERATURE IS:** _____°

Checked operation of alarm system on unit.

Note: Alarm can be simulated by temporarily raising setpoint out of range.

Checked temperature recorders for proper operation (If applicable).

Note: If there are any deviations observed, further diagnosing may be required.

Check operation of CO2 or LN2 backup system. (If applicable)

**ITEMS BELOW MUST BE CHECKED BY YOUR IN-HOUSE TECHNICAL PROFESSIONAL
USE CAUTION WHEN WORKING AROUND ELECTRICAL CIRCUITS**

Checked AMP draw of unit when compressors stabilize.

Checked incoming voltage and voltage drop when compressors start up.

◆ NOTES

◆ COMPLETED BY

◆ COMPLETED DATE

NOTE: DIAGRAM ONLY APPLIES TO STANDARD CONFIGURATION (115 VOLTS), AND MAY NOT NECESSAIRLY APPLY TO YOUR SPECIFIC UNIT. CONSULT A CERTIFIED REFRIGERATION EXPERT.

ALARM DIAGRAM

TEMPERATURE CONTROL

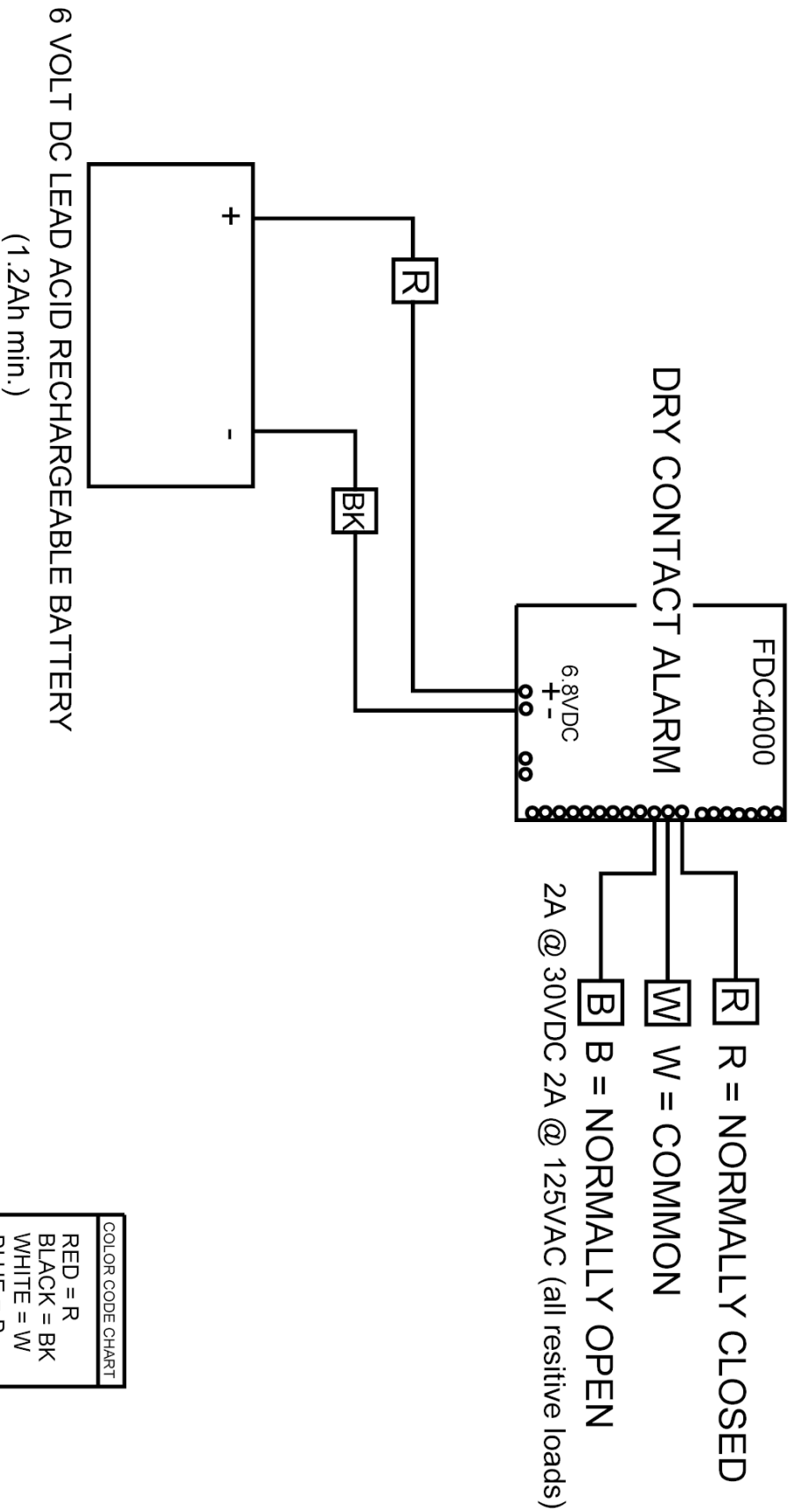

COLOR CODE CHART	
RED = R	
BLACK = BK	
WHITE = W	
BLUE = B	

11-2007

NOTE: DIAGRAM ONLY APPLIES TO STANDARD CONFIGURATION (115 VOLTS), AND MAY NOT NECESSAIRLY APPLY TO YOUR SPECIFIC UNIT. CONSULT A CERTIFIED REFRIGERATION EXPERT.

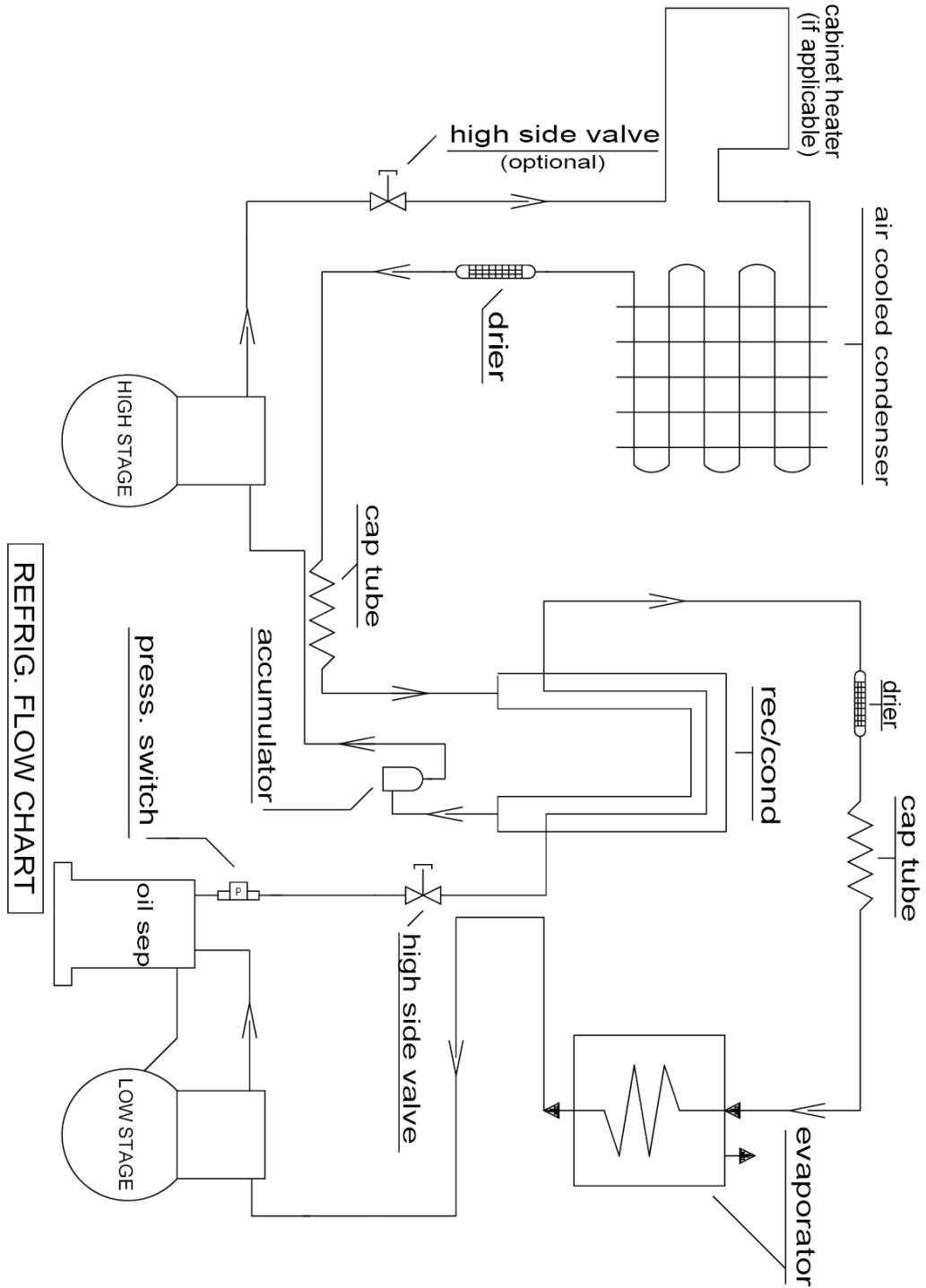

REFRIG. FLOW CHART

HOT GAS BYPASS CASCADE FLOW CHART
4-19-2010